



PERCH Instruction Manual

Congratulations!

You are now the owner of a Nurseryworks product...a line of modern baby furniture that redefines the nursery. Nurseryworks' products are designed with both style and functionality in mind, and we hope it becomes a source of pleasure for you and your family. Quality material, workmanship and pride have gone into these products. Proper assembly is important to ensure a safe and comfortable end result for your baby. Please read all instructions before assembly, and keep instructions for future use.

The Product and Manufacturing Process:

Nurseryworks products are made from sustainable woods wherever possible and also from high-quality wood veneers. The primary material used in our products is Paulownia wood which is harvested from plantations and renewed every 10-12 years. Zero-grade MDF, containing well below the regulated limit of formaldehyde, is used sparingly in components of our products to achieve our signature carvings and single board slat cut-outs. All paints, finishes and glues are low-VOC. Our products are tested on a frequent basis to ensure that all coatings and finishes comply with U.S. and Canadian heavy metals requirements.

Each Nurseryworks product is a unique piece crafted largely by hand. We use a specialized machinery process to create our hallmark carvings and each piece is constructed and lacquered by hand. Our lacquering process involves over a dozen steps to sand and polish the furniture to achieve our glossy finish. With proper care and assembly, your Nurseryworks products will be a part of your family for years to come. Please note that due to the handcrafted nature of our products and our use of solid woods, each piece is unique and may contain irregular qualities, such as natural markings, miniscule burrs, or slight discolorations. These natural characteristics are inherent in wood, are not considered manufacturing defects and do not merit replacements.

Maintenance and Cleaning:

To preserve the hand-crafted quality of Nurseryworks furniture, we recommend using a cotton cloth and a non-toxic cleaner. Periodic polishing or oiling on wood stains will help to maintain the rich wood tones. For our upholstered products, we recommend using water to clean suede products and light foam cleaner for all other fabrics.

If your child is teething, some furniture's finish may be affected. Be assured that our low-VOC lacquers, finishes and glues comply with applicable regulations and standards. Touch up kits and replacement parts are available for purchase upon request by contacting Nurseryworks at:
323. 728. 8988 or info@nurseryworks.net.

Important Note:

Improper assembly can result in damage to your furniture or cause harm to your child. Proper assembly is critical to ensure a safe and comfortable end result. Please read all instructions before assembly and keep instructions for future use.

Thank you for purchasing Nurseryworks. For any questions or assistance, please contact us at 323. 728. 8988, or via email at info@nurseryworks.net. For additional information on our Purchase Terms and Conditions, please visit www.nurseryworks.net. Your authorized Nurseryworks retailer will also be happy to assist you.



Welcome to Nurseryworks Family Privileges

A sound savings plan that helps you furnish your futures, and your children's rooms, for less.

Here's how Family Privileges works:

When you are making purchases of Nurseryworks furniture for more than one child, take advantage of a fast family privilege.

Take US\$100 off any second crib or changing table when making your Nurseryworks initial purchase.*

And there's more:

When the time comes to purchase from the Nurseryworks kids' furniture collection, simply provide proof of your original Nurseryworks purchase and take US\$100 off your total purchase.**

Nurseryworks stays a part of your family by making sure your style budget doesn't have to expand when your family does.

That's Nurseryworks Family Privileges.

* Products include the Aerial Crib, Loom Crib, Studio Crib, Loom Changing Table, and Two Wide Changing Table. Discount does not apply to any toddler daybed conversion kits.

** Products include the Duet Bunk Bed and Duet Twin Bed. Nurseryworks reserves the right to change the terms of this offer based on product availability.

WARNING

- Failure to follow these warnings and the assembly instructions could result in serious injury or death.
- Read all instructions before assembling this product.
- Keep instructions for future use.
- FALL HAZARD – To prevent death or serious injury, always keep child within arm's reach.
- Check this product for damaged hardware, loose joints, missing parts or sharp edges before and after assembly and frequently during use. DO NOT use this product if any parts are missing, damaged or broken. Contact Nurseryworks, Inc. for replacement parts and instructional literature if needed. DO NOT substitute parts.
- Assembly tool required: Phillips screwdriver (not included).
- Tighten all screws securely at each step of the instructions. Check frequently to be certain they remain tight and secure.
- If refinishing, use a non-toxic finish specified for children's products.
- This product contains small parts. Keep small parts out of children's reach during assembly.
- Properly discard all packaging materials after assembly is complete.

ONE YEAR LIMITED WARRANTY:

We will replace any missing parts at the time of purchase or any defective item within a one year period from the date of original purchase. Please keep your receipt so that we may process your warranty request. This warranty only covers new units with original packaging and ownership, and is not transferable. It does not cover any used, second-hand or demo models.

This warranty does not cover any damaged or defective parts that result from installation and assembly, normal wear and tear, abuse, negligence, improper use or alteration to the finish, design, and hardware of the rocker. The specific legal rights of this warranty may vary from state to state. Some states do not allow any exclusion or limitation of incidental damages. Some States do not allow limitation on how long an implied warranty lasts.

Registering your product is even easier than before. You can register your product on our website at : www.nurseryworks.net

IF YOU WOULD LIKE TO ORDER REPLACEMENT OR MISSING PARTS. PLEASE VISIT US AT:

WWW.NURSERYWORKS.NET



OR YOU CAN CONTACT US BY MAIL:

855 Washington Blvd. Montebello, CA 90640

Tel: 323. 728. 8988

Fax: 323. 722. 2805

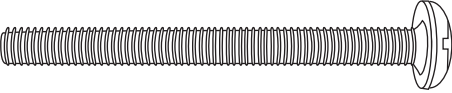
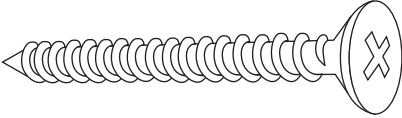
Perch Hardware List

Hardware	Ref.No	Description
	Ax4	Screw (60mm/2.4")
	Bx8	Screw (50mm/2")
	Cx4	Washer
	Dx4	Spring Washer

Please note that screw B requires a Phillips Head Screw driver which is not provided.

Perch Parts List

Parts	Ref.No	Description
-------	--------	-------------



①x2

Leg

(these can be found underneath the Perch)

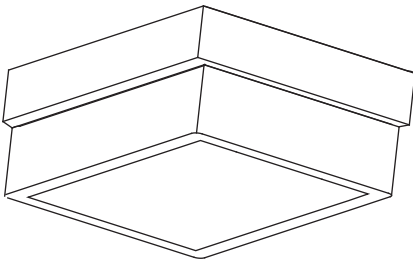

②x1

Perch

★ Be sure you follow the instructions in the order that they appear.
To avoid possible scratching, assemble furniture on a soft surface.
For instance on a carpet or blanket.

Be aware that you can use both ends of the Allen wrench.
For instance, use it lengthwise to get into tighter corners.

Be careful not to over tighten screws.

Perch Assembly Instructions

Step 1



Put the Spring washer **D** into Screw **A** and then followed by washer **C**. Repeat the same procedures for all 4 Screws **A**.

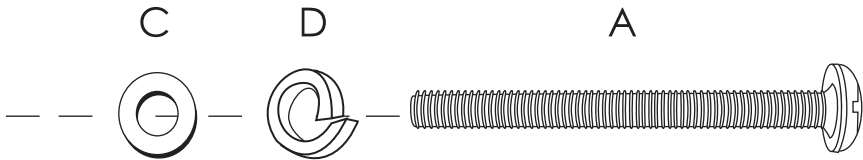

Step 2



Connect the legs **1** to the wooden frame of the rocker by inserting screws **A** into the pre-instead nuts of the wooden frame and screw them tightly using the wrench. Repeat the same procedures for 4 corners. Then insert 2 Screws **B** into the pre-drilled holes of the leg and screw it into the wooden frame tightly using a screw driver.

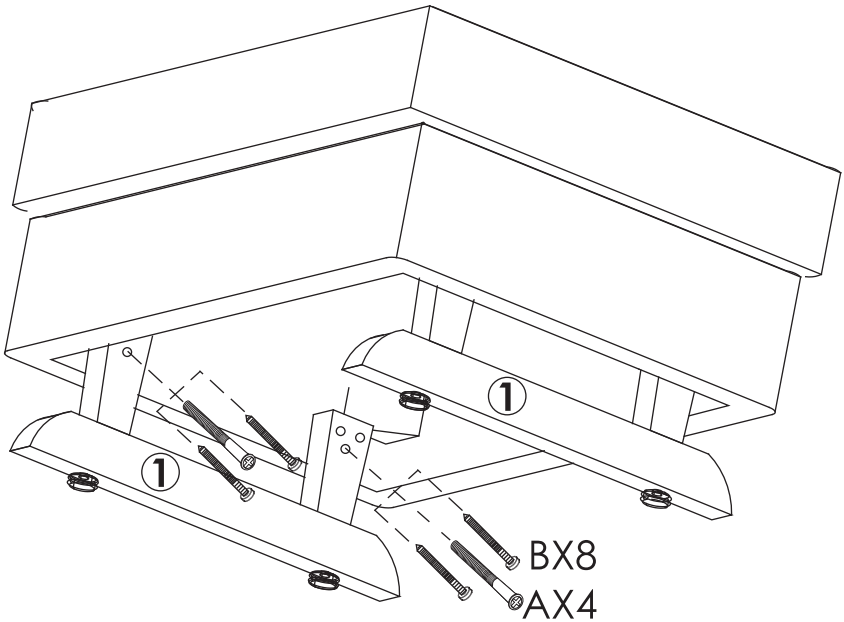



www.nurseryworks.net